

1. CTS brugerpanel skal placeres i det ventilerede område da T15 er styrende føler
2. Brugerpanel SKAL monteres frostfrit
3. Komponenter med stiplede forbindelse er tilbehør
4. Optionsprint er tilbehør til CTS602
5. Eksterne komponenter er ikke Nilan Leverance
6. Ⓐ – Ⓔ Tilslutning af EL-supplering

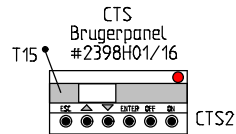

Min. 4x2x0,5mm², max. 50m
Parsnoet

Strømforsyning
1N 230V~ 50Hz max. 13A

Sikkerhedsafbryder

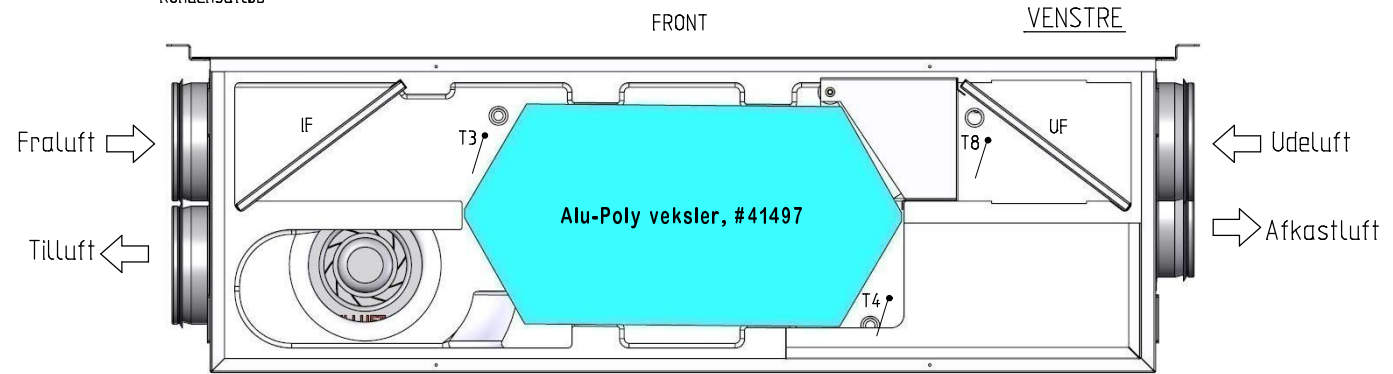
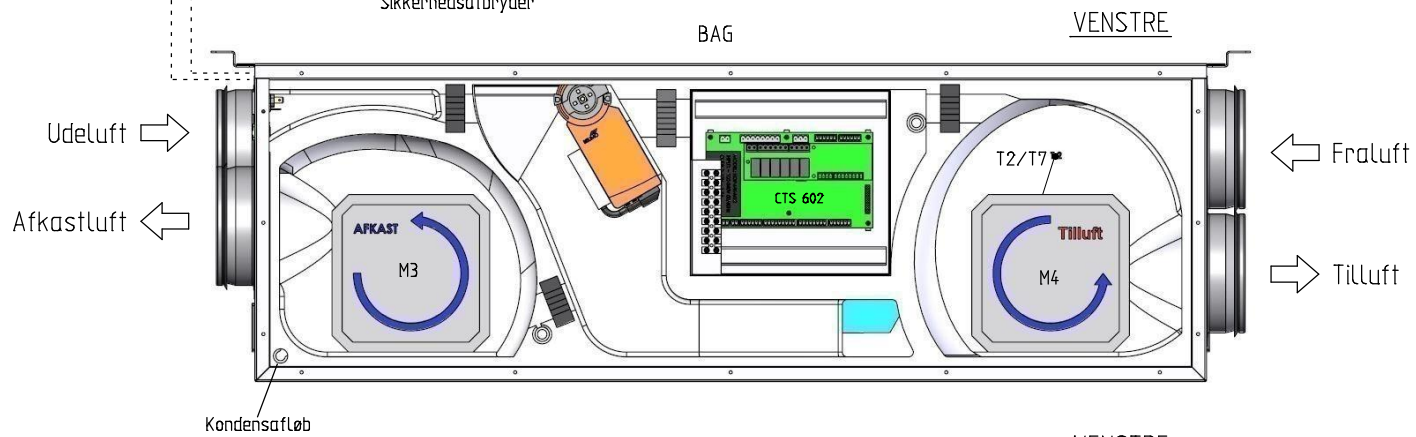
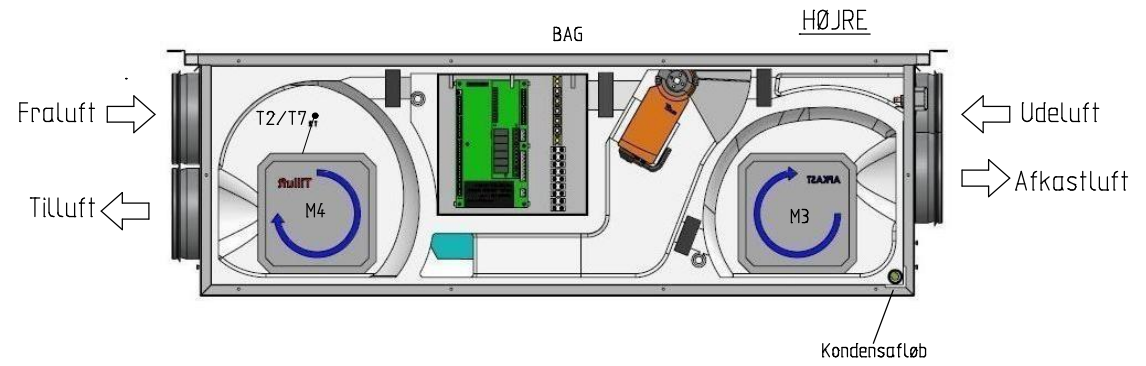

NILAN A/S
 Nilanvej 2
 DK-8722 Hedensted
 Tlf. +4576752500
 Fax +4576752525
<http://www.nilan.dk>
 Email: nilan@nilan.dk

Comfort CT150, CTS-panel (Brandautomatik)
 CTS602
 Varenr. 7115x10 & 40

Principdiagram

Ordrenr.	Revision	1.09	Initialer	MD
Dato	Nationalitet	DK / N / S / SF	Side	1
31/03-2017				

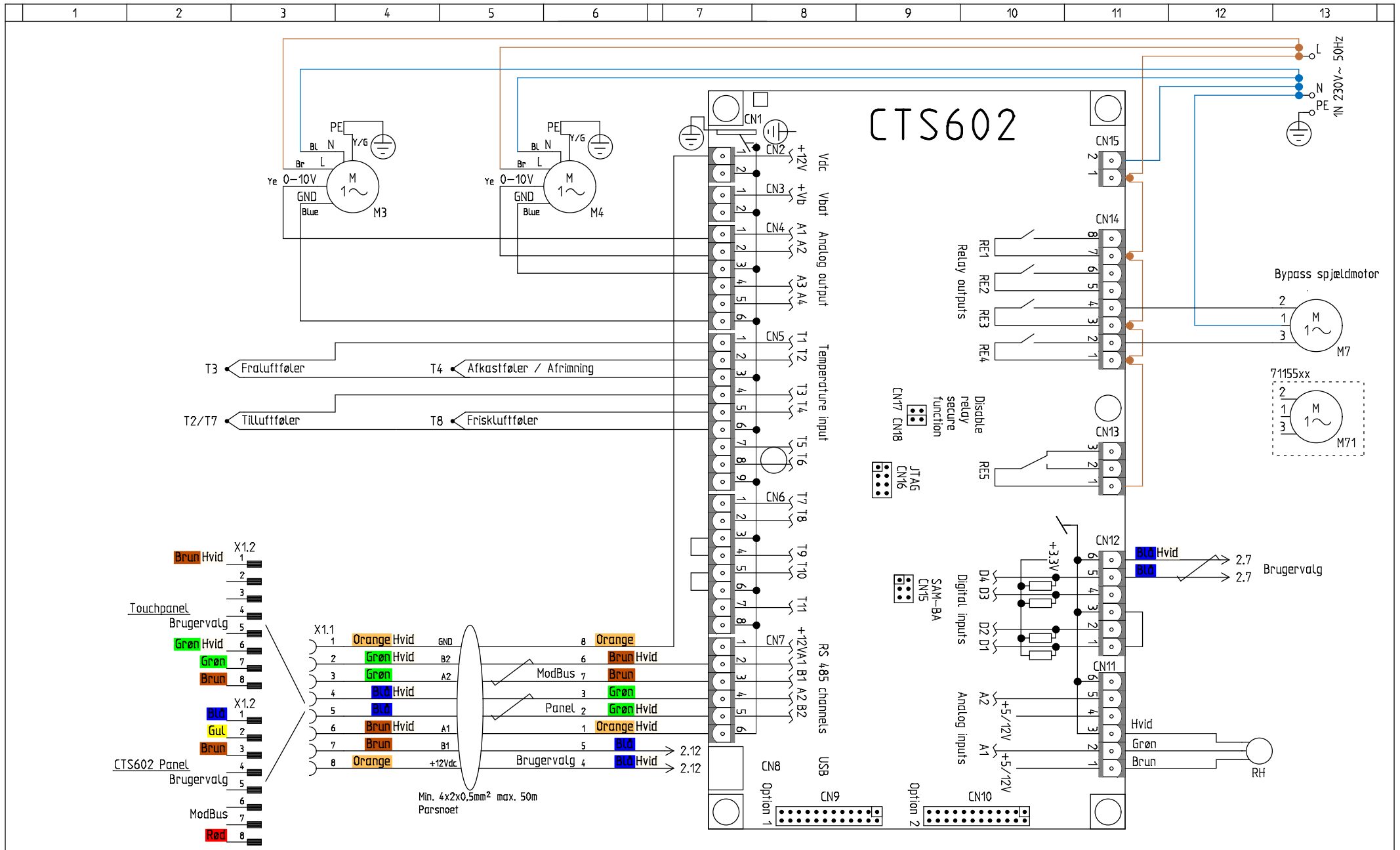

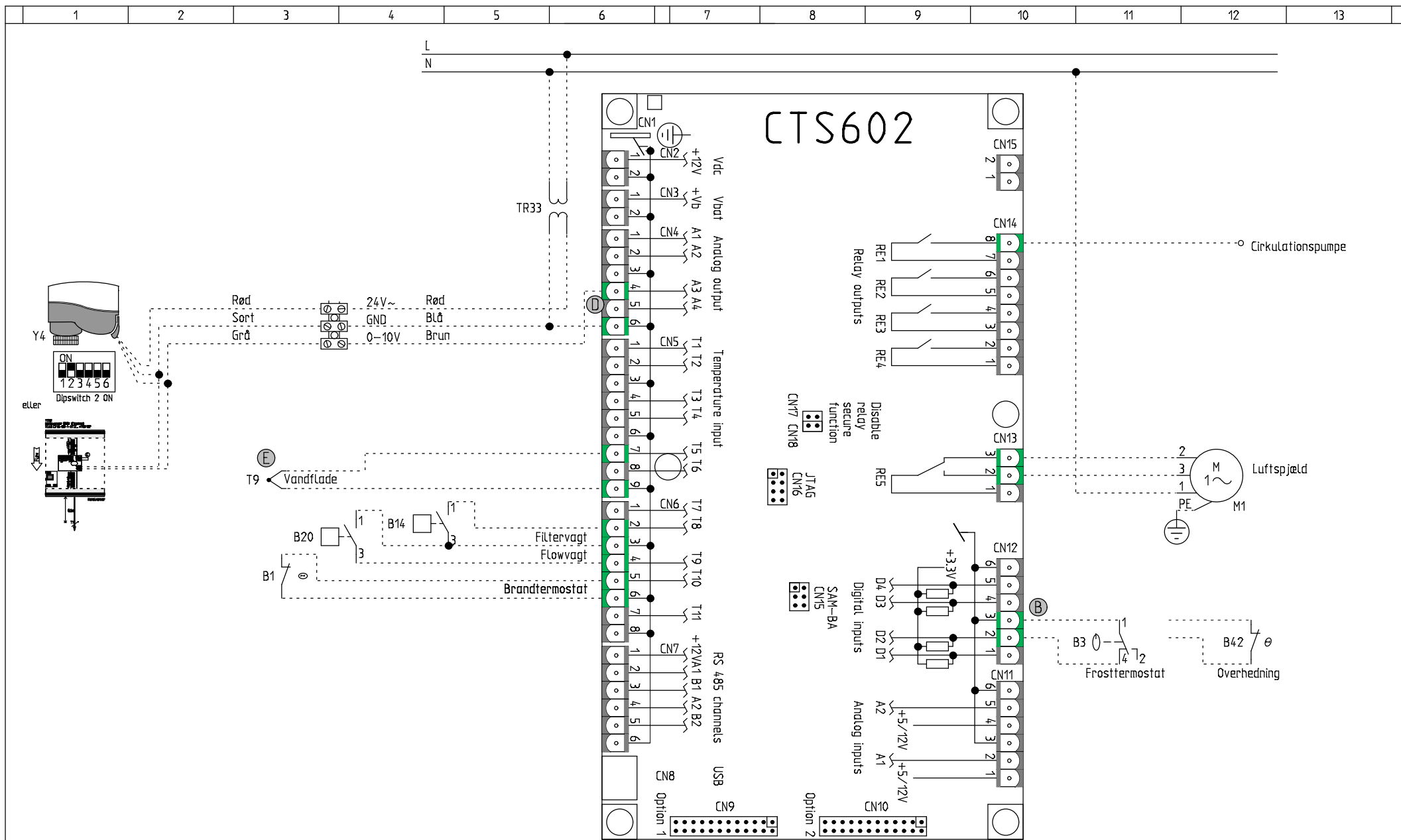

NILAN A/S
 Nilanvej 2
 DK-8722 Hedensted
 Tlf. +4576752500 <http://www.nilan.dk>
 Fax +4576752525 Email : nilan@nilan.dk

Comfort CT150, CTS-panel (Brandautomatik)
 CTS602
 Varenr. 7115x10 & 40

Tilbehør

Ordrenr.	Revision 1.09	Initialer MD
Dato 31/03-2017	Nationalitet DK / N / S / SF	Side 3

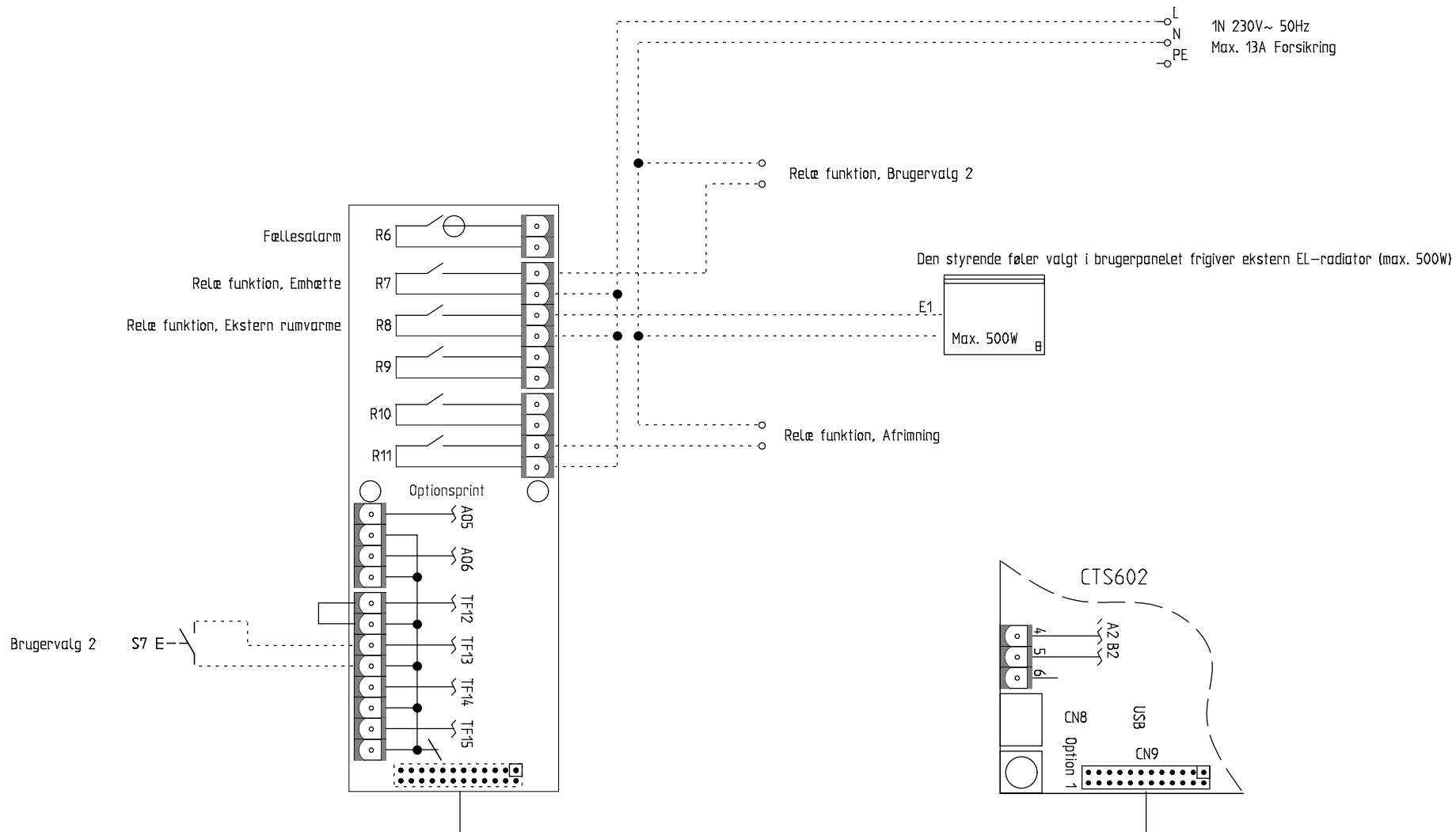

Produktliste

Produkt	Type	Beskrivelse	Dokumenttype	Side	Strømvej
B1	EGO 55.33519.020 70-5°C, #15441	Brandtermostat Tilluft (Tilbehør)	Kredsskema	3	3
B3	Termostat, #15662	Frosttermostat (Tilbehør)	Kredsskema	3	10
B14	Huba 20-300Pa, #3635	Filtervagt (Tilbehør)	Kredsskema	3	5
B20	Huba 20-300Pa, #3635	Flowvagt (Tilbehør)	Kredsskema	3	4
B42	EGO 55.13019.180 60°C, #1564	Begrænsertermostat EL-supplering (Tilbehør)	Kredsskema	3	12
E1	EL-varme Max. 500W	Ekstern rumvarme (Ej Nilan leverance)	Kredsskema	4	8
IF	G4 NGB-290/4, #39170	Udeluft filter	Kredsskema	1	5
M1	Evt. LindabSafe DTBU LMC 230F, #8425	Luftspjæld (Tilbehør)	Kredsskema	3	11
M3	ebm K3G133-RA01-01 0.26A 230V~, #4120	Fraluftmotor	Kredsskema	2	4
M4	ebm K3G133-RA01-01 0.26A 230V~, #4120	Tilluftmotor	Kredsskema	2	6
M7	Belimo CM230-F-L, #36463	Bypass spjældmotor	Kredsskema	2	12
M71	Belimo CM230-F-R, #36464	Bypass spjældmotor	Kredsskema	2	12
Print	#239938	Optionsprint (Tilbehør)	Kredsskema	4	4
RH	#23997	Fugtføler	Kredsskema	2	11
S7	Kontakt	Brugervalg 2 (Ej Nilan leverance)	Kredsskema	4	2
T2/T7	NTC-føler JM103C1R1, #23995	Tilluftføler	Kredsskema	2	3
T3	NTC-føler JM103C1R1, #23995	Fraluftføler	Kredsskema	2	3
T4	NTC-føler JM103C1R1, #239961	Afkastføler / Afrimning	Kredsskema	2	5
T8	NTC-føler JM103C1R1, #23995	Friskluftføler	Kredsskema	2	5
T9	NTC-føler JM103C1R1, #23995	Vandflade	Kredsskema	3	3
TR33	230/24V~, #1753	Transformer (Tilbehør)	Kredsskema	3	6
UF	G4 NGB-290/4, #39170	Fraluft filter	Kredsskema	1	9
X1.1			Kredsskema	2	4
X1.2			Kredsskema	2	3
X1.2			Kredsskema	2	3
Y4	Danfoss AME140, #16341	Modulerende vandvarmeventil (Tilbehør)	Kredsskema	3	1
11201	VEAB CV16-09-1-MTXL, #764132	Kanalvarmer 900W (Tilbehør)	Kredsskema	3	1



Comfort CT150, CTS-panel (Brandautomatik)
 CTS602
 Varenr. 7115x10 & 40

Projekt
 7115x10 40 V1-09 170331

Antal sider
 1

Dato
 03-04-2017

Land
 DK / N / S / SF

Næste side

Side
 1